



S3000, S5000, S7000

Getting Started Guide

i Before starting please check www.allen-heath.com for the latest dLive firmware and documentation.

Limited Three Years Manufacturer's Warranty

Allen & Heath warrants the Allen & Heath -branded hardware product and accessories contained in the original packaging ("**Allen & Heath Product**") against defects in materials and workmanship when used in accordance with Allen & Heath's user manuals, technical specifications and other Allen & Heath product published guidelines for a period of THREE (3) YEARS from the date of original purchase by the end-user purchaser ("**Warranty Period**").

This warranty does not apply to any non-Allen & Heath branded hardware products or any software, even if packaged or sold with Allen & Heath hardware.

Please refer to the licensing agreement accompanying the software for details of your rights with respect to the use of software/firmware ("EULA").

Details of the EULA, warranty policy and other useful information can be found on the Allen & Heath website: www.allen-heath.com/legal.

Repair or replacement under the terms of the warranty does not provide right to extension or renewal of the warranty period. Repair or direct replacement of the product under the terms of this warranty may be fulfilled with functionally equivalent service exchange units.

This warranty is not transferable. This warranty will be the purchaser's sole and exclusive remedy and neither Allen & Heath nor its approved service centres shall be liable for any incidental or consequential damages or breach of any express or implied warranty of this product.

Conditions Of Warranty

The equipment has not been subject to misuse either intended or accidental, neglect, or alteration other than as described in the User Guide or Service Manual, or approved by Allen & Heath. The warranty does not cover fader wear and tear.

Any necessary adjustment, alteration or repair has been carried out by an authorised Allen & Heath distributor or agent.

The defective unit is to be returned carriage prepaid to the place of purchase, an authorised Allen & Heath distributor or agent with proof of purchase. Please discuss this with the distributor or the agent before shipping. Units returned should be packed in the original carton to avoid transit damage.

DISCLAIMER: Allen & Heath shall not be liable for the loss of any saved/stored data in products that are either repaired or replaced.

Check with your Allen & Heath distributor or agent for any additional warranty information which may apply. If further assistance is required please contact Allen & Heath Ltd.

dLive Surface Getting Started Guide Issue 4

Copyright © 2021 Allen & Heath. All rights reserved.

ALLEN & HEATH

Allen & Heath Limited, Kernick Industrial Estate, Penryn, Cornwall, TR10 9LU, UK

<http://www.allen-heath.com>

IMPORTANT - Read before starting

Safety instructions

Before starting, read the **Important Safety Instructions** printed on the sheet supplied with the equipment. For your own safety and that of the operator, technical crew and performers, follow all instructions and heed all warnings printed on the sheet and on the equipment panels.

System operating firmware

The function of the dLive Surface is determined by the firmware (operating software) that runs it. Firmware is updated regularly as new features are added and improvements made.

① Check www.allen-heath.com for the latest version of dLive firmware.

Software licence agreement

By using this Allen & Heath product and the software within it you agree to be bound by the terms of the relevant **End User Licence Agreement** (EULA), a copy of which can be found at www.allen-heath.com/legal. You agree to be bound by the terms of the EULA by installing, copying, or using the software.

Further information

Please refer to the **Allen & Heath website** for further information, knowledgebase and technical support. For more information on dLive setup and mixing functions please refer to the dLive Firmware Reference Guide available for download at www.allen-heath.com.

① Check for the latest version of this Getting Started Guide.

You can also join our Allen & Heath Digital Community to share knowledge and information with other dLive users.

General precautions

- Protect the equipment from damage through liquid or dust contamination. Cover the Surface when it is not being used for a long period.
- If the equipment has been stored in sub-zero temperatures allow time for it to reach normal operating temperature before use at the venue. Recommended operating temperature is 0 to 35 degrees Celsius.
- Avoid using the equipment in extreme heat and direct sunlight. Make sure the ventilation slots are not obstructed and that there is adequate air movement around the equipment.
- Clean the equipment with a soft brush and dry lint-free cloth. Do not use chemicals, abrasives or solvents.
- It is recommended that servicing is carried out only by an authorised Allen & Heath agent. Contact details for your local distributor can be found on the Allen & Heath website. Allen & Heath do not accept liability for damage caused by maintenance, repair or modification by unauthorised personnel.
- To prevent damage to the controls and cosmetics, avoid placing heavy objects on the control surface, scratching the surface or touchscreen with sharp objects, or rough handling and vibration.

Register your product

Register your product online at www.allen-heath.com/register.

Packed items

Check you have received the following:

- dLive Surface
- Getting Started Guide AP9899
- Safety Sheet
- IEC mains lead
- Dust cover

Contents

IMPORTANT - Read before starting	3
Packed items	4
Contents	4
1. Introduction.....	5
1.1 dLive Surfaces	5
2. Rear Panel	7
3. Front Panel	10
3.1 Harmony UI – processing screen.....	12
3.2 Harmony UI – system screen	13
3.3 Fader strip.....	15
3.4 Working with the Mix.....	16
4. Connect and power up	17
4.1 MixRack connection.....	17
4.2 Recall a Template Show	17
4.3 Expander connection.....	17
4.4 Connect a laptop or wireless router	18
5. Dimensions.....	19
6. Technical specs.....	20

1. Introduction

dLive is a distributed digital mixing system providing a uniquely flexible solution for any live sound application. It separates the mix engine from the control surface, putting the audio and processing where it is needed, and offering a host of control and audio networking possibilities. Refer to the Allen & Heath website to find out more about dLive.

The **MixRack** is the heart of any dLive system. It houses the XCVI processing core complete with audio I/O, control and audio networking ports. The **Surface** is effectively a network controller for the MixRack, with the addition of built-in audio I/O and audio networking ports. The system can be expanded by adding up to 3 DX32 modular racks, and is compatible with the ME personal mixing system.

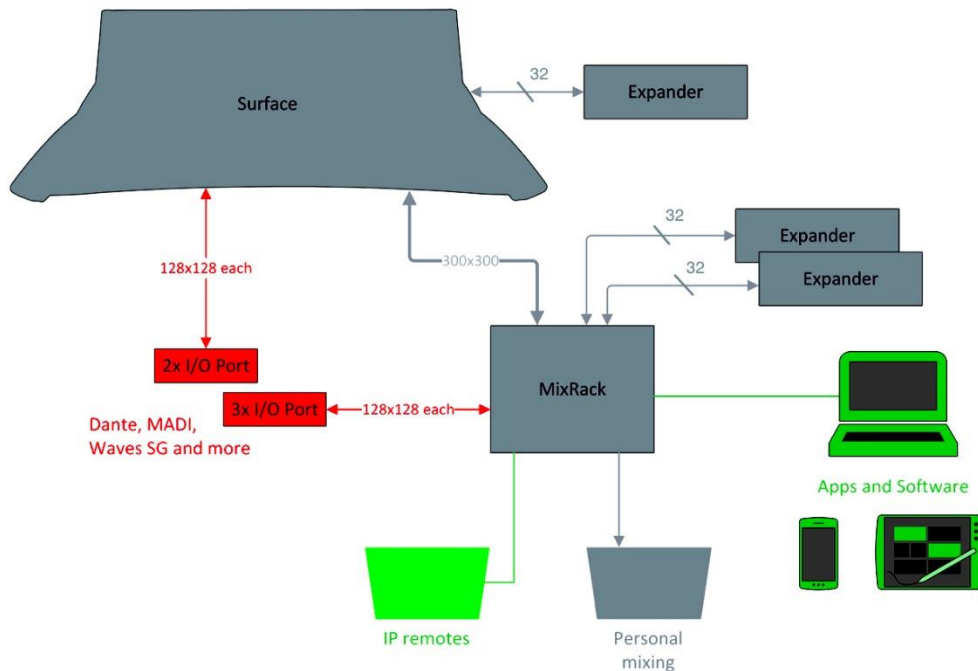

1.1 dLive Surfaces

There are 3 sizes of dLive Surface available. All feature the same I/O and differ only in the number of faders and touchscreens.

dLive Surface features at a glance:

- Fully assignable layout
- Harmony UI – integrated screen and ‘wrap-around’ controls
- Single or twin 12” capacitive touchscreen
- Gesture control – pinch, swipe, drag ‘n drop
- Configurable widget areas for Scenes, meters, FX and more
- 3 pages of assignable rotaries per screen
- 26 assignable SoftKeys
- Engineer’s Wedge and IEM fader strips
- Comprehensive multipoint metering
- Daylight visibility
- USB stereo recording and playback
- Dual redundant, hot swappable power supply

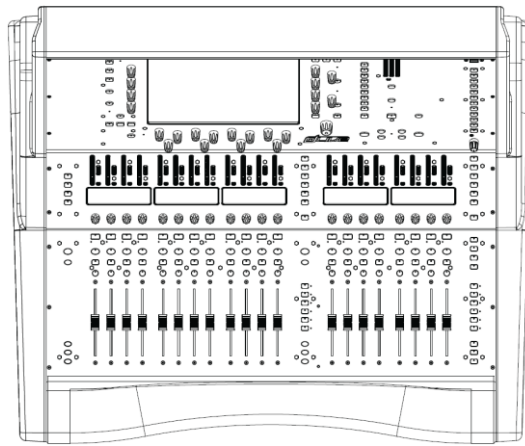

S3000

20 faders, 6 layers = 120 strips

Single screen

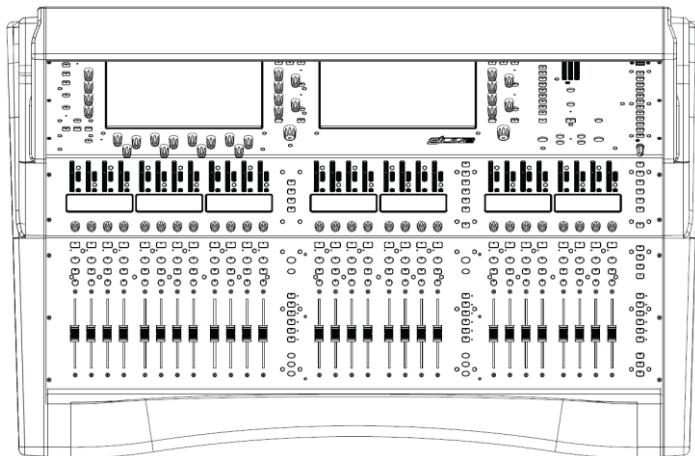

S5000

28 faders, 6 layers = 168 strips

Twin screen

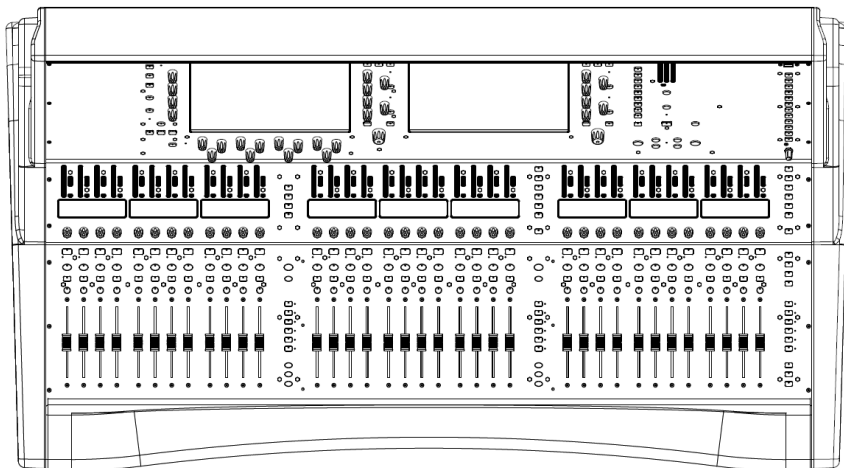

S7000

36 faders, 6 layers = 216 strips

Twin screen

2. Rear Panel

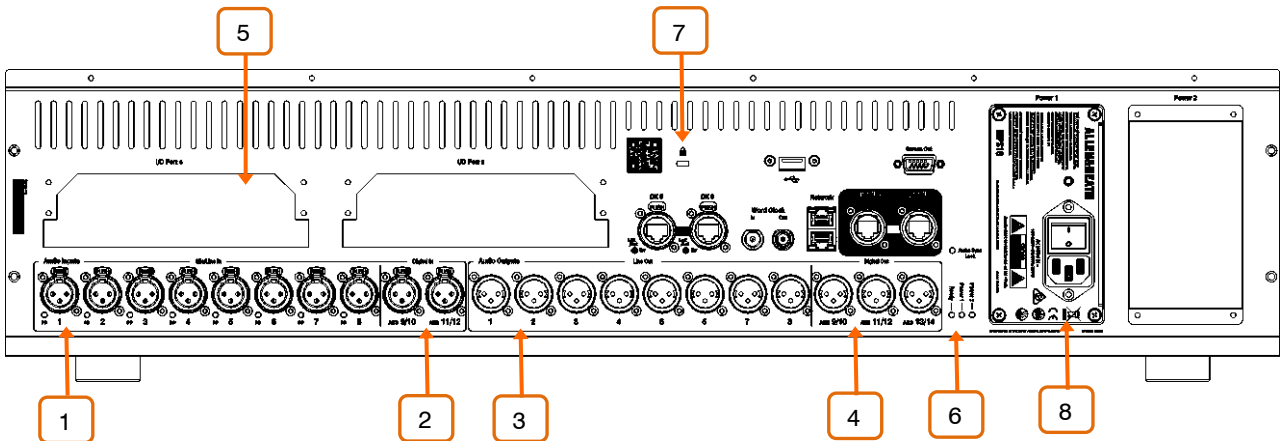

1 Mic/Line inputs – 8x recallable preamps for balanced or unbalanced microphone and line level signals. Gain, Pad and 48V are digitally controlled within the preamp.

The PP indicator lights up when phantom power voltage is detected at the socket, whether internally or externally sourced.

Any socket can be patched to any Input Channel using the **I/O** or **Processing / Preamp** screen.

2 Digital inputs – 2x stereo AES3 inputs (32kHz – 96kHz sampling rate). Sample Rate Conversion can be bypassed.

Any socket can be patched to any Input Channel using the **I/O** or **Processing / Preamp** screen.

3 Line outputs – 8x line level, balanced XLR outputs. Nominal level +4dBu. The outputs are relay protected to prevent power on or off thumps.

Signals can be patched to any output socket using the **I/O** screen.

4 Digital outputs – 3x stereo AES3 outputs (48kHz or 96kHz switchable).

Signals can be patched to any output socket using the **I/O** screen.

5 I/O Ports – 2x audio interface ports 128x128 channels each, independently assigned. Fit one of the option cards available for system expansion, digital mic splitting, recording or distributed audio networking. Refer to www.allen-heath.com for a list of available option cards.

i iLive / GLD option cards (M-Dante, M-Waves, M-ES-V2, M-ACE, M-MADI) can be used with dLive when fitted with the M-DL-ADAPT ‘letter-box’ adapter. This provides a 64x64 48kHz interface with built-in Sample Rate Conversion.

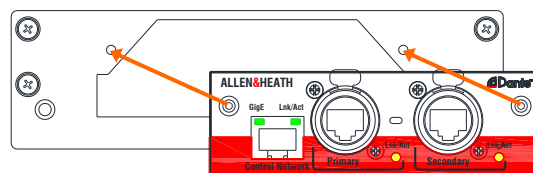

Use the **I/O** screen to patch signals from or to the I/O Ports.

6 Status indicators – Power ON indicators for the 2 power supplies. The Ready indicator lights up when the output sockets are ready to pass audio after power up. Audio Sync Locked indicates a valid clock source.

7 Kensington Lock - A slot for fitting standard Kensington anti-theft security devices.

8 Power Supply – Hot swappable power supply with mains IEC socket and On/Off rocker switch. To remove or replace, loosen the 4 screws indicated below and slide the PSU out of the slot.

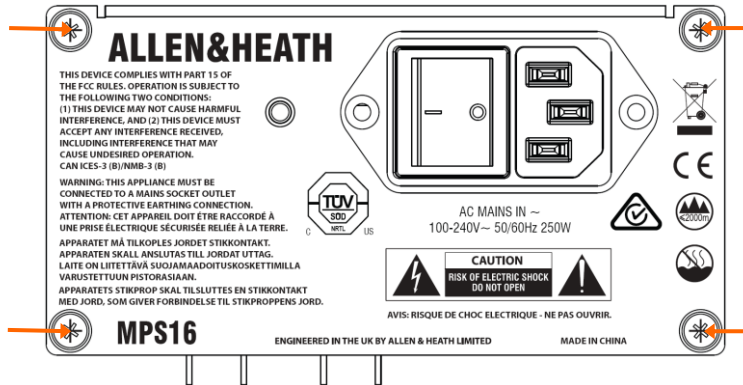

i dLive Surfaces ship with one PSU fitted. A second PSU can be fitted for redundancy (part number MPS-16). Loosen the 4 captive thumb screws securing the blank panel*, slide the PSU into the slot, and tighten the 4 captive thumb screws indicated above. The Surface will automatically switch between the supplies without interruption to the audio should one fail.

* On early dLive units, remove the 4 screws securing the blank panel using a star Torx T8 screwdriver.

i Heed the safety warnings printed on the panel.

A plastic P-clip cable clamp is provided to secure the mains cable. Slot the cable in or lock it in place using a star Torx T20 screwdriver to refit the clamp around the cable.

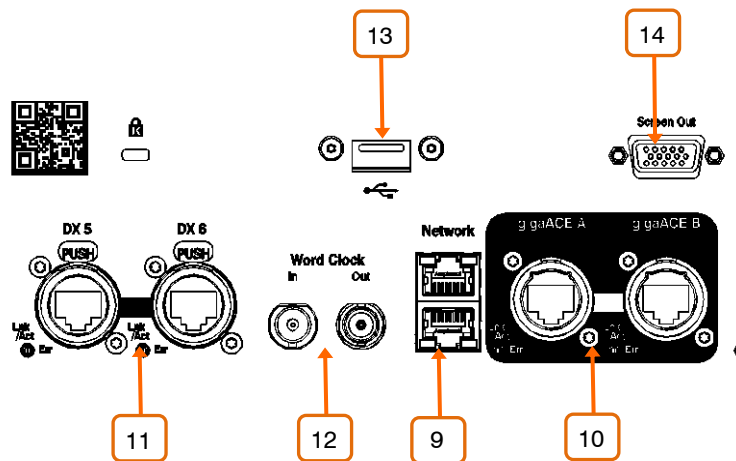

9 Network – 2 RJ45 Gigabit Ethernet ports. Connect a laptop or a wireless router to use with dLive Editor or iOS apps. All devices on the network must have compatible IP addresses.

10 gigaACE link – MixRack to Surface link over Gigabit Ethernet (IEEE 802.3 Layer 2 compliant). A single Cat5e (or higher) cable carries bidirectional 96kHz audio and control. Use two cables for redundancy – the system will seamlessly switch cable in case of failures, without any audio dropout.

11 DX links – Dual redundant EtherCon port for connection of a DX expander over Fast Ethernet (IEEE 802.3 Layer 2 compliant). A single Cat5e (or higher) cable carries 32x32 channels of 96kHz audio and control. Use two cables for redundancy.

Use the **I/O** screen to patch signals from or to the DX expanders.

12 Word Clock I/O - BNC connectors for syncing from an external audio clock or providing a clock to other devices.

13 USB – USB A port for file transfer, archive and firmware update using standard USB drives.

14 Screen Out – VGA port for connection of an external monitor. The external monitor can mirror either of the touchscreen views. Use the **Surface / Screen** screen to configure.

 External touchscreens are not supported.

3. Front Panel

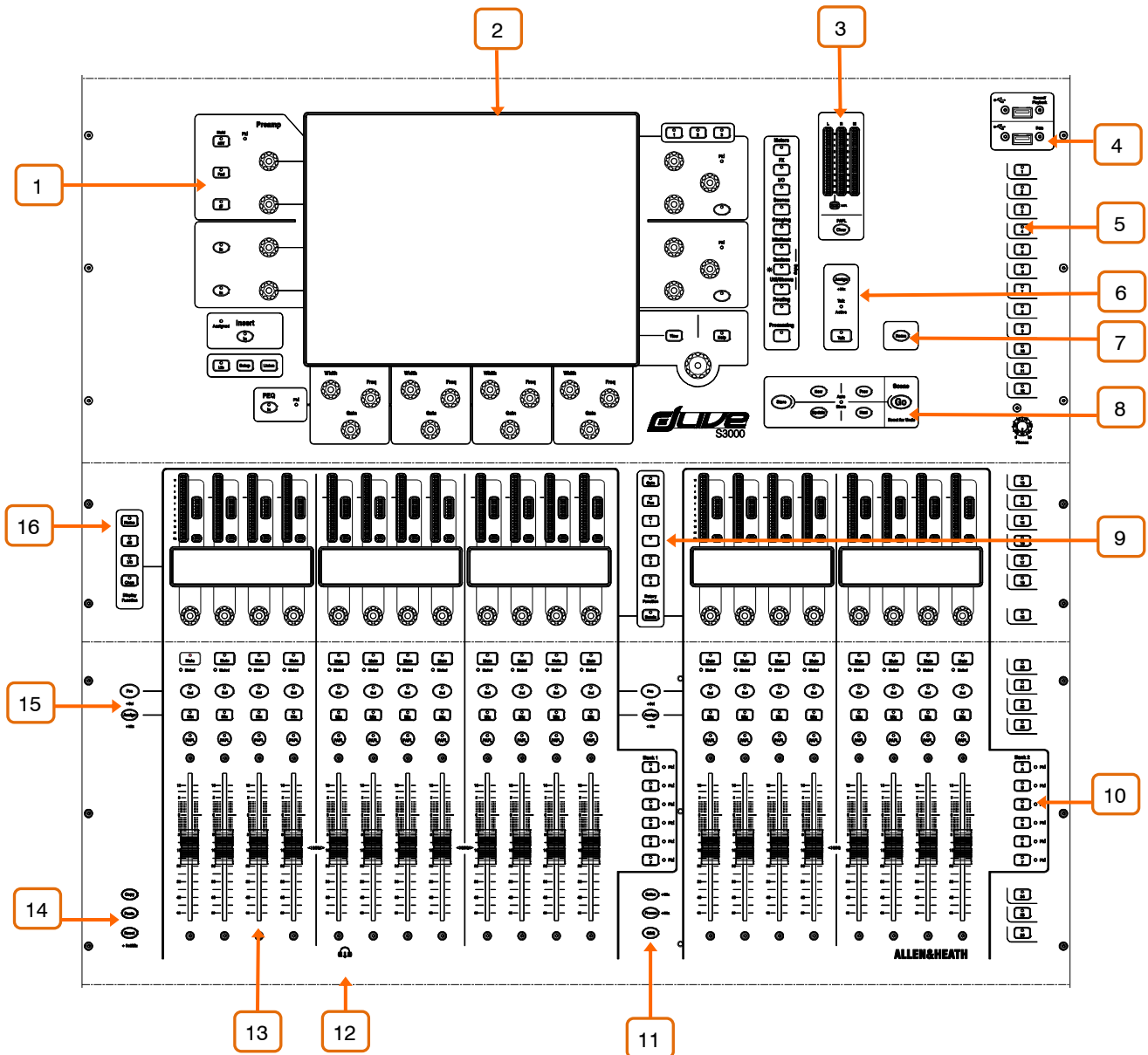

- 1 **Channel Processing** – Press a fader strip **Sel** key to access the processing for the input or mix channel assigned to it. Read the Harmony UI paragraph below for further information.
- 2 **Touchscreen** – Single or twin 12” capacitive touchscreen with gesture control and daylight visibility. Read the Harmony UI paragraph below for further information.
- 3 **Main / PAFL meters** – LCR meters with PAFL active indicator. Press **PAFL Clear** to cancel any active PAFL.
- 4 **USB ports** – The upper port is dedicated to stereo WAV file recording and playback. The lower port is for data transfer of Show files, Libraries, event logs and firmware updates.

5 **SoftKeys** – 26 user assignable keys. Assign functions using the **Surface / Control / SoftKeys** screen.

6 **Talkback** – Press to Talk latching or momentary key and Talk Active indicator. Hold down Assign and press any master **Mix** key to assign.

7 **Home** – Press to restore a familiar state of the Surface. Home restores default active layers, screen modes, active Mix, strip rotary mode and channel LCD view.

i Home does not affect channel processing, strip layout, illumination or any other setting which is stored in Scenes.

8 **Scene navigation** – Press **Go** to recall the Next scene as indicated in the upper right corner of the system screen. This Scene is highlighted in green in the Scenes menu and Scenes widget. Use the **Prev** and **Next** keys to select the Next scene before recalling.

Hold down Reset and press **Go** to Undo an accidental recall and restore previous settings.

Store - Save current settings into the Current scene as indicated in the upper left corner of the system screen. This Scene is highlighted in yellow in the Scenes menu and Scenes widget.

i Auto Store automatically stores the current (last recalled) Scene any time another Scene is recalled. The LED lights to indicate this option is active.

New - Save current settings into a new, empty Scene. The next available scene memory location will be populated with current settings.

Update - Update one or more parameters or channels in a specific Scene (or range of Scenes) to current settings / values.

9 **Strip rotary mode** – Select the function of the fader strip rotary encoders. The fader strip rotaries can control preamp Gain, Pan, Sends to the active Mix, and 4 assignable functions. Assign these using the **Surface / Control / Preferences** screen. The colour of the rotary LED matches the active function e.g. red for Gain, yellow for Pad; it follows the colour of the active Mix when in Sends mode.

The **Sends** function puts control of send levels to the active Mix on the strip rotaries, while the faders control the channel levels to the main mix i.e. it temporarily inhibits 'sends on faders'.

10 **Layers** – Navigate 6 layers of fader strips per each bank. The red peak indicators light up when any channel in the associated layer is within 3dB of clipping, so you can keep a check on signal activity across the layers.

Banks can be linked using the **Surface / Control / Preferences** screen – the Layer keys will affect all linked banks. For example you might want all input strips across 2 banks to stay 'in sync' when changing layer.

11 **Safes** – Hold down and press a strip **Mix** key to make the channel safe from Scene recall. To make only a selection of parameters safe, use the **Scenes / Scene Safes** screen.

Freeze in Layers – Hold down and press a strip **Mix** key to lock a channel in place across all layers.

GEQ on Faders – Presents the GEQ for a selected mix on the faders. Press to toggle between high and low frequencies (S3000, S5000) and exit. Frequency values are shown on the strip LCD displays and the strip meters show RTA activity of each frequency band and peak band indication. This is useful for ringing out monitors or identifying trouble frequencies.

The mix master fader is presented on the right hand strip while in this mode.

12 **Phones** - Standard 1/4" and 1/8" jack sockets are located under the armrest. The S5000 and S7000 have 2 sets of headphone outputs.

13 Fader Strips – Provide control of Input channels, FX returns, Mix masters, DCAs, engineer’s Wedge / IEM monitor, or MIDI. Read the Fader Strip paragraph below for further information.

The strip layout is user assignable and stored in Scenes. Use the **Surface / Control / Strip Assign** screen to edit the strip layout.

14 Copy – Hold down and press:

- A strip **Sel** key to copy the channel processing.
- A strip **Mix** key to copy the mix assignments and send levels.
- Any highlighted area of the touchscreen to copy the settings of a specific processing block.

Paste - Hold down and press a **Sel** key, **Mix** key or highlighted area of the touchscreen to paste copied settings.

Reset - Hold down and press a **Sel** key, **Mix** key or highlighted area of the touchscreen to reset the related parameters to factory default.

Hold down Reset and nudge a fader up or down to quickly set it to 0dB or off.

15 Assign – Hold down and press a strip **Mix** key to toggle its assignment to the active Mix on or off.

Pre/Post – Hold down and press a strip **Sel** key to toggle sends to the active Mix pre or post fade.

Toggle all channels on/off or pre/post by pressing a master **Mix** or **Sel**.

Assignments and pre/post settings for the selected channel or Mix are also available in the **Routing** screen.

16 LCD Display mode – Select the information shown in the strip LCD Displays. Read the Fader Strip paragraph below for further information.

3.1 Harmony UI – processing screen

The left screen on the S5000 and S7000 is dedicated to channel processing. The S3000 incorporates this screen into the system screen.

dLive integrates the touchscreen with a set of ‘wrap-around’ controls colour-coded for intuitive and quick operation. Dedicated areas of the screen display values and status of the corresponding controls; some are configurable or user assignable (widget areas). Tapping on any of these areas will open the associated tab in the main screen area.

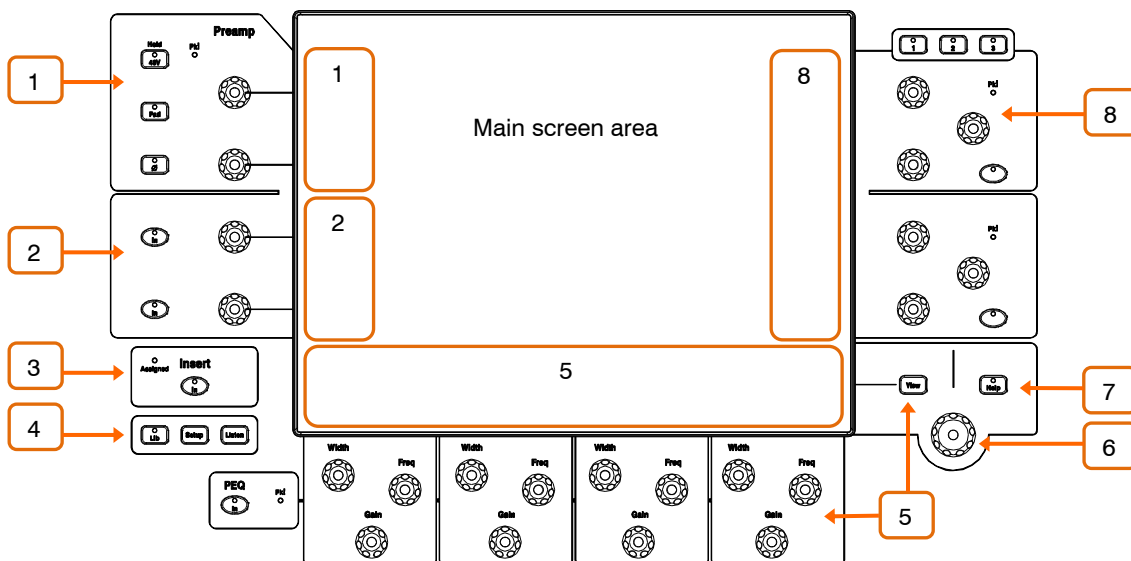

1 **Preamp** – Peak indicator and dedicated preamp controls for analogue Gain, Digital Trim, 48V, Pad and polarity.

2 **Filters** – HPF and LPF Frequency and In switch.

3 **Insert** – Insert In switch and Assigned indicator. The indicator is lit when any of the channel Insert points is assigned.

4 **Lib** – Press to access the preset Library for the channel or processing block in focus. A popup menu lets you Recall, Store, Overwrite or Delete libraries. Press Lib again to exit.

Setup – Hold down and tap on any highlighted area of the screens to configure it. For example, touch a widget area to set up functions, views or controls. Touch on the main screen area to access options further to those displayed.

Listen – Hold down and tap on any highlighted area of the screen to listen to that point in the signal path of the selected channel. The signal temporarily overwrites the PAFL bus and associated meters.

5 **PEQ** – In switch, peak indicator and Width, Frequency, Gain controls for the 4 bands of parametric EQ.

A dedicated area of the screen displays the PEQ parameters and/or response curve, either individually for the 4 bands or full range. Hold down **Setup** and touch this area to configure. Press **View** to toggle between the configured views.

6 **Touch & Turn** – Touch a parameter or setting in the main screen area and adjust its value with the rotary control.

7 **Help** – Press to display a brief contextual help for the active screen.

8 **Soft Rotaries** – 2 blocks of 3 assignable rotaries over 3 layers, per screen. Each block has its own In switch and peak indicator.

A dedicated area of the screen displays the parameters for the assigned controls and thumbnail indicators where available. Hold down **Setup** and touch this area to configure. Press the keys on top of the rotaries, or swipe within the widget area to toggle between the 3 layers.

ⓘ Note that the Soft Rotaries can be configured to follow channel selection, active Mix or to be locked to a specific channel.

3.2 Harmony UI – system screen

The system screen (right screen on the S5000 and S7000) displays status, system setup, memory management menus and more.

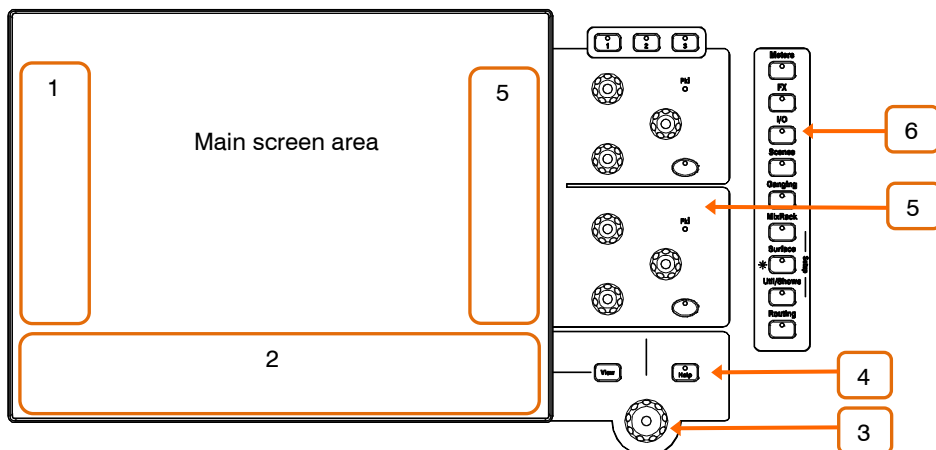

1 **Left widget area** – Can be configured for different functions, for example as a scrollable Scenes list. Hold down **Setup** and touch this area to configure.

On the S3000 this area is dedicated to the channel processing.

2 **Bottom widget area** – Can be configured for different functions, for example as a scrollable meter-bridge. Hold down **Setup** and touch this area to configure. Press **View** to toggle between the configured views.

3 **Rotary control** – Adjusts the value of the parameter highlighted in yellow on the main screen area.

4 **Help** – Press to display a brief contextual help for the active screen.

5 **Soft Rotaries** – 2 blocks of 3 assignable rotaries over 3 layers, per screen. Each block has its own In switch and peak indicator.

A dedicated area of the screen displays the parameters for the assigned controls and thumbnail indicators where available. Hold down **Setup** and touch this area to configure. Press the keys on top of the rotaries, or swipe within the widget area to toggle between the 3 layers.

i Note that the Soft Rotaries can be configured to follow channel selection, active Mix or to be locked to a specific channel.

6 **Screen modes** – Press to select the menus for the main screen area.

Meters – Access to Input meters, FX meters, Mix meters, RTA, spectrogram, and 4 customisable meter views.

FX – View, load and set up the 16 RackFX units. The Back Panel view lets you patch each unit as inserted or send/return.

I/O – Patch system inputs and outputs by tapping on crosspoints.

Scenes – Access to Scene Manager, Cue Lists and Scene Safes.

Gangging – Create up to 16 gang groups to link selected parameters across multiple channels.

MixRack Setup – Access to mixer bus configuration, Input stereo configuration, Network settings, User Profiles, Talkback assignments, Signal Generator, Audio Sync and I/O Ports options.

Surface Setup – Assignments of fader strip layout, SoftKeys and custom rotary functions. Control of Surface illumination and USB Audio playback / recording. Access to PAFL options and Network settings.

i Press and hold the Surface Setup key to quickly access the Dimmer settings. Whilst holding the Surface Setup key, use the Rotary Control to change the Touchscreen brightness.

Util/Shows – Access to Show Manager, Library Manager, system diagnostics, screen and fader calibration, firmware update and MIDI MMC.

Routing – Access to routing and assignments for the selected channel.

Processing (S3000) – Channel processing screen for the selected channel.

When no screen mode is selected, a **System Status** dashboard is displayed. Touch Power Down in this screen to safely power down the Surface before switching off.

3.3 Fader strip

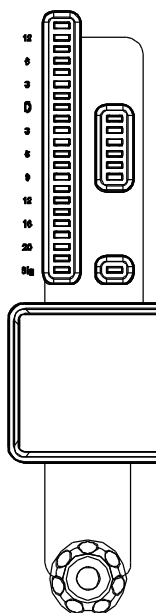

Meter – 22-segment signal meter and 6-segment gain reduction meter. The meter displays audio signal activity for the channel.

The red peak indicator lights to warn that the signal is within 3dB of clipping. It is multi-point sensing which means it detects peak activity at several points in the signal path. If it lights before the rest of the meter, check signal activity in the processing screen.

i To set the global meter source point for Input channels and Mix masters, hold down Setup and touch the main screen area in the **Meters / Inputs** or **Meters / Mix** screen.

LCD Display – Displays information about the channel, including name and colour.

Strip rotary – Their function is selected using the strip rotary mode keys as described earlier in this chapter. The rotaries can control preamp Gain, Pan, Sends to the active Mix, and 4 assignable functions. The colour of the rotary LED matches the active function e.g. red for Gain, yellow for Pad; it follows the colour of the active Mix when in Sends mode. The value is displayed in the LCD display.

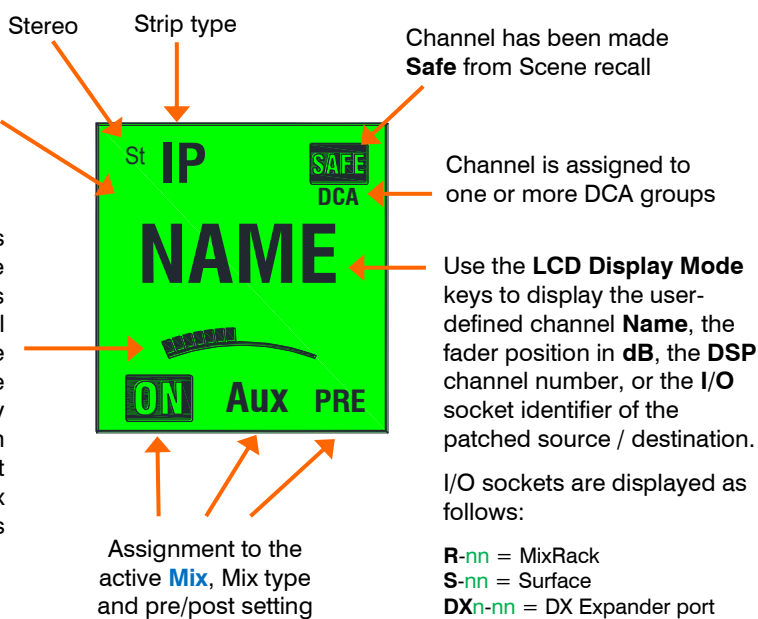

Mute – Turns off the channel signal. Affects the main mix, pre-fade and post-fade sends. The Muted LED lights when the channel is muted by a DCA or Mute Group.

Muted



Sel – Selects the channel for use with the Processing and Routing screens. The channel strip controls become active to control processing for the channel.

i The currently selected channel is displayed in the top left corner of the Processing screen.



Mix – Puts the send levels and assignments of the associated channel or masters onto the fader strips (or strip rotaries when rotaries are in Sends mode). See the next paragraph for examples of use.



i The currently active Mix is displayed in the top right corner of the Processing screen. Press an active **Mix** key to return to the main mix.

PAFL – Sends the channel signal PFL (pre-fade listen) or AFL (after-fade listen) to the headphones and monitoring system. Preferences for the PAFL system are set using the **Surface / Audio / PAFL** screen.

3.4 Working with the Mix

Normal mix mode (FOH)

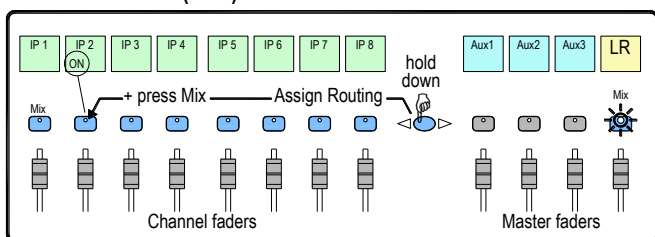

Press a Main Mix master strip **Mix** key.

This is the normal mixing mode. The Input strips present the channel faders. The Master strips present the master mix faders.

Hold down the **Assign** key and press channel **Mix** keys to assign or unassign them from the main mix. Current ON status is displayed on the lower part of the strip LCDs.

Master Mix view

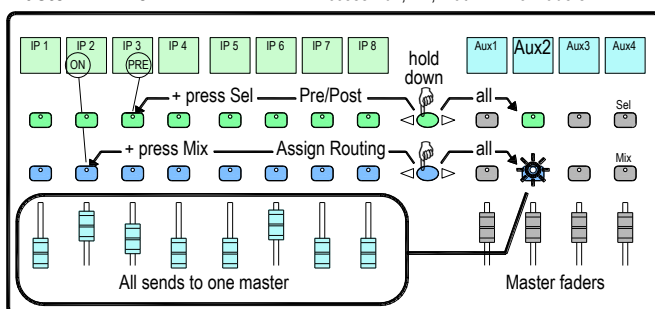

Press a Mix master strip **Mix** key.

Use this to work with Aux and FX sends. The Input strips present all the send levels to the active Mix. The Master strips present the master mix faders.

Hold down the **Assign** key and press channel **Mix** keys to assign or unassign them from the active Mix.

Hold down the **Pre/Post** key and press channel **Sel** keys to toggle each source pre or post fader. Current PRE status is displayed on the lower part of the channel strip LCDs.

You can quickly set **all** assignments on or off, or all sources pre or post fader by pressing the Master strip **Mix** or **Sel** key.

Channel Mix view

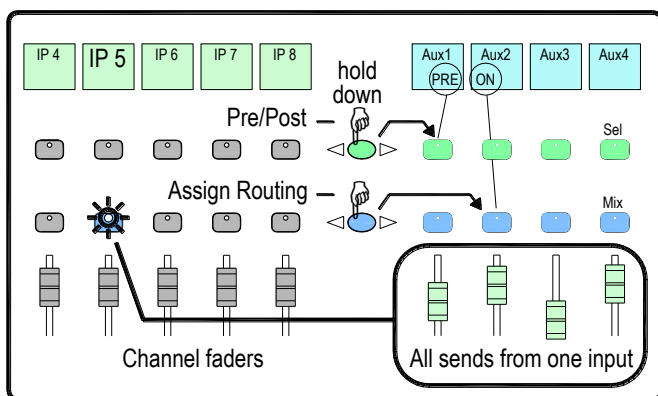

Press an Input Channel strip **Mix** key.

Use this to work with Aux and FX sends. The Input strips remain as Channel Faders. The Master strips present all sends from the Input channel.

Hold down the **Assign** key and press master **Mix** keys to assign or unassign the channel from each mix.

Hold down the **Pre/Post** key and press master **Sel** keys to toggle the channel pre or post fader to each mix. Current PRE status is displayed on the master strip LCDs.

DCA and Audio Group assign

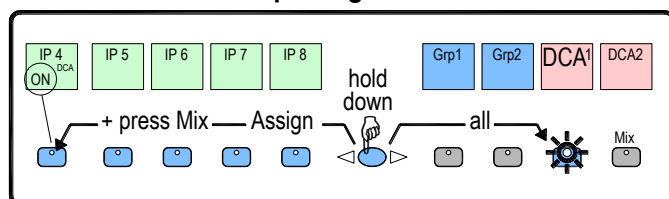

Press a Group Master strip **Mix** key.

Use this to assign channels to the Audio and DCA groups. The Input and Master faders are not affected.

Hold down the **Assign** key and press channel **Mix** keys to assign or unassign the channels from the group.

4. Connect and power up

4.1 MixRack connection

Plug a touring grade CAT5e (or higher specification) cable up to 100m long between the dLive Surface and MixRack gigaACE ports. Use two cables for redundancy if required.

- ① Refer to www.allen-heath.com for cable requirements, recommendations, and a list of CAT5 cables available to order.

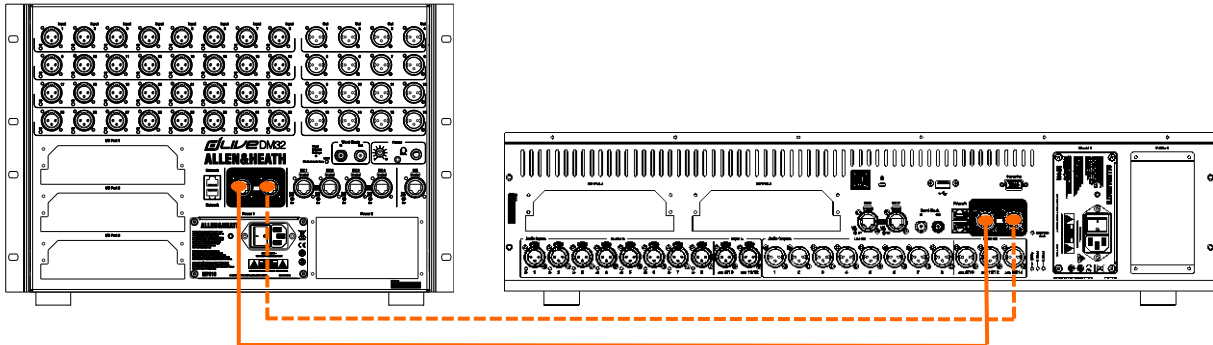

Switch on the MixRack first, then the Surface. The gigaACE Lnk/Err indicators flash at a steady rate when the link is established. The red error indicator lights if a communication error is detected. Check that the cables are correctly plugged in and are not faulty.

It takes around 30s for the Surface to take control and the touchscreen to be responsive.

4.2 Recall a Template Show

dLive has a fully configurable audio architecture, control layout and socket patching. We have provided a set of Template Shows to give a choice of classic console formats to load as a quick starting point. These present the familiar architecture and logical layout of well-equipped analogue consoles.

To load a Template Show go to the **Utility / Show Manager** screen, select one of the available Template Shows, touch **Recall** and confirm.

- ① Recalling a Show overwrites all the system settings including the bus configuration, control layout, current parameters, all Scenes and Library presets. If you want to save the current settings then first **Store** them as a User Show.
- ① For more information please refer to the dLive Firmware Reference Guide available for download at www.allen-heath.com.

4.3 Expander connection

Plug a touring grade CAT5e (or higher specification) cable up to 100m long between the DX Expander and Surface DX port. Use two cables for redundancy if required.

- ① Refer to www.allen-heath.com for cable requirements, recommendations, and a list of CAT5 cables available to order.

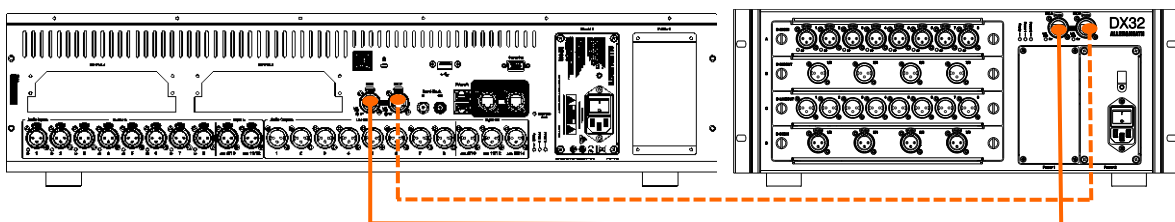

Switch on the DX Expander. The DX port Lnk/Err indicators flash at a steady rate when the link is established. The red error indicator lights if a communication error is detected. Check that the cables are correctly plugged in and are not faulty.

4.4 Connect a laptop or wireless router

Connect a laptop, router or access point to either of the Network ports to use with dLive Editor or iOS apps. Read the Release Notes and Help Files accompanying the software or apps for further information.

- ① dLive communicates over TCP/IP. All devices on the network including the MixRack and Surface must have compatible IP addresses. Factory defaults are:

MixRack	192.168.1.70
Surface	192.168.1.71
Subnet Mask	255.255.255.0
Gateway	192.168.1.254

For direct, wired laptop connections, set your laptop to a static, compatible IP address, for example **192.168.1.10**.

For wireless connections, set your router / access point to a compatible IP address, for example 192.168.1.254, and its DHCP range to a compatible range of addresses, for example **192.168.1.100 to 192.168.1.200**. Set any wireless laptop or mobile device to DHCP / 'obtain an IP address automatically'.

5. Dimensions

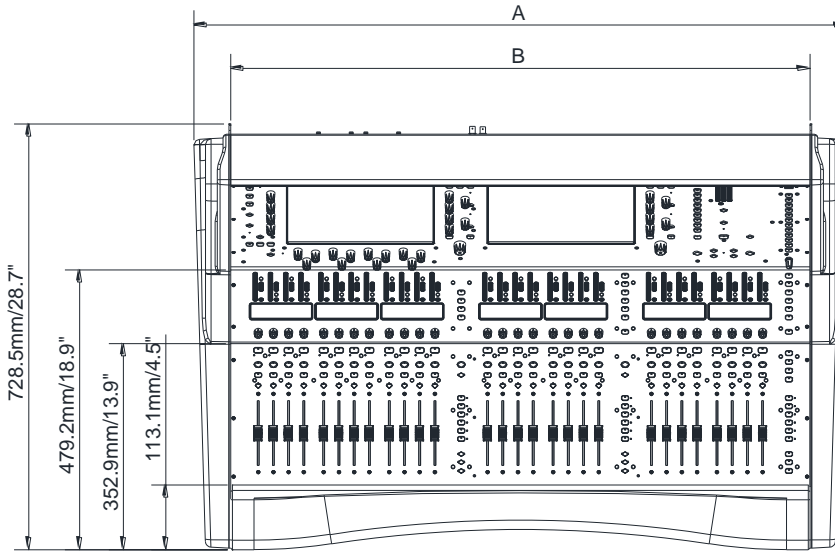

- A**
 S3000 - 870mm/34.2"
 S5000 - 1115.4mm/43.9"
 S7000 - 1325.4mm/52.2"
- B**
 S3000 - 744.5mm/29.3"
 S5000 - 990mm/39"
 S7000 - 1200mm/47.3"

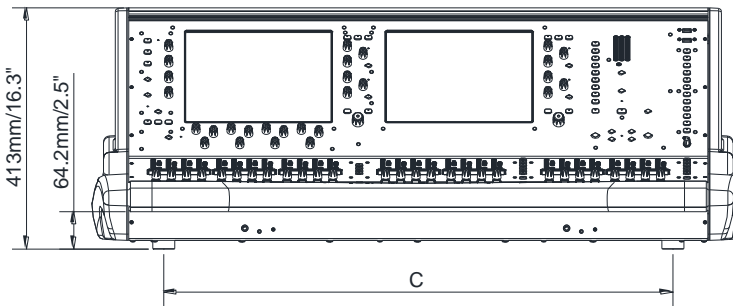

- C**
 S3000 - 624.5mm/24.6"
 S5000 - 870mm/34.3"
 S7000 - 1080mm/42.5"

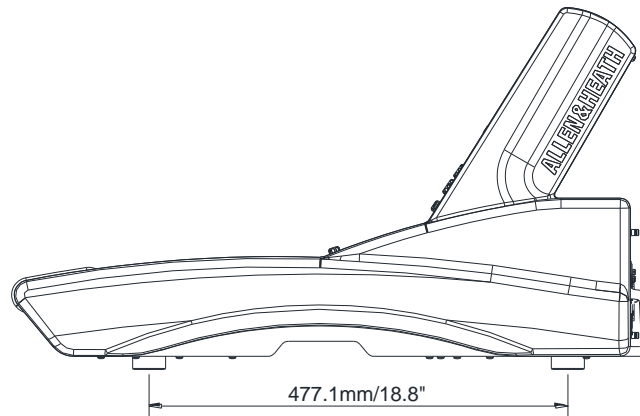

6. Technical specs

Inputs

Mic/Line XLR Inputs	Balanced XLR, +48V phantom power
Mic/Line Preamp	Fully recallable
Input Sensitivity	-60 to +15dBu
Analogue Gain	+5 to +60dB, 1dB steps
Pad	-20dB Active PAD
Maximum Input Level	+30dBu (PAD in)
Input Impedance	>4k Ω (Pad out), >10k Ω (Pad in)
Mic EIN	-127dB with 150 Ω source
Phantom Power indication	Per socket, internal or external phantom power sensing, triggered at 24V

Digital Inputs

AES3 2 Ch XLR, 2.5Vpp balanced terminated 110 Ω
SRC on each pair, range 32k - 192kHz, with bypass option

Outputs

Analogue XLR Outputs	Balanced, Relay protected
Output Impedance	<75 Ω
Nominal Output	+4dBu = 0dB meter reading
Maximum Output Level	+22dBu
Residual Output Noise	-92dBu (muted, 20-20kHz) -90dBu (muted, 20-40kHz)

Digital Outputs

AES3 2 Ch XLR, 2.5Vpp balanced terminated 110 Ω
96kHz sampling rate, switchable to 48kHz, 44.1kHz

USB Audio

USB Audio playback	Mono/stereo .WAV files, 16/24bit, 44.1/48/96kHz
USB Audio recording	Stereo .WAV files, 24bit 96kHz

Dimensions and Weights

	<i>Width x Depth x Height x Weight</i>
S3000	870 x 728 x 413 mm x 28kg (34.3" x 28.7" x 16.3" x 62lbs)
S5000	1115 x 728 x 413 mm x 35kg (43.9" x 28.7" x 16.3" x 77lbs)
S7000	1325 x 728 x 413 mm x 41kg (52.2" x 28.7" x 16.3" x 90lbs)

System

Measured balanced XLR in to XLR out, 20-20kHz, minimum Gain, Pad out	
Dynamic Range	110dB
System Signal to Noise	-92dB
Frequency Response	20Hz - 30kHz +0/-0.8dB
THD+N (analogue in to out)	0.0015% @ +16dBu output, 1kHz 0dB gain
Headroom	+18dB
Internal operating Level	0dBu
dBFS Alignment	+18dBu = 0dBFS (+22dBu at XLR output)
Meter Calibration	0dB meter = -18dBFS (+4dBu at XLR out)
Meter Peak indication	-3dBFS (+19dBu at XLR out)
Sampling Rate	96kHz +/- 20 PPM

ADC

24-bit Delta-Sigma

DAC

24-bit Delta-Sigma

Latency

0.7 ms (MixRack XLR in to XLR out, Input to Mix)
+ 5 samples, Surface to Mixrack (GigaACE hop)
+ 8 samples, DX32 to Mixrack (DX hop)

Power

Mains Voltage Operating Range	100-240V AC, 50/60Hz
Mains Power Consumption	300W max (MPS16 V1 300W)* 250W max (MPS16 V2 250W)*

ⓘ MPS16 power consumption is printed under AC inlet

Temperature

Operating Temperature Range

Fitted with MPS16 V1 300w	0°C to 35°C (32°F to 95°F)
Fitted with MPS16 V2 250w	0°C to 40°C (32°F to 104°F)

Boxed

	<i>Width x Depth x Height x Weight</i>
S3000	1045 x 920 x 560 mm x 41kg (41.1" x 36.2" x 22" x 90.4lbs)
S5000	1290 x 920 x 560 mm x 50kg (50.8" x 36.2" x 22" x 110.2lbs)
S7000	1485 x 920 x 560 mm x 56kg (58.5" x 36.2" x 22" x 123.5lbs)