

Z4MK3/Z8MK3 : Zone Mixers



Z4MK3 Zone Mixer



Z8MK3 Zone Mixer

General Description

The Cloud Z4MK3 and Z8MK3 are multi-zone, rack-mounting (3U) audio mixers. They combine simple control of background music with versatile microphone paging for up to eight separate areas. They are suitable for use in many types of premises, including pubs, bars, clubs, shops, offices, hotels, etc.

Both models have six stereo line inputs and three microphone inputs, one of which is configured specifically for use with paging mics. The Z4MK3 has four separate mono zone outputs, and the Z8MK3 eight; apart from the number of supported zones, the models are identical. The front panel provides separate controls for music source selection, music level and two mic levels in each zone. EQ cards suitable for various popular makes and models of installed sound loudspeakers may be fitted to any or all outputs.

The Z4MK3 and Z8MK3 are directly compatible with Cloud PM Series paging microphones; alternatively, the paging mic input can be configured to suit most OEM paging systems. Zone selection for paging is via short-to-ground access connections, and each zone may be independently configured for music ducking, triggered either by the access port or VOX control. The ducking feature has selectable

release times. The paging mic has priority over the other mic inputs (Mic 1 and Mic 2). Paging mic level to each zone is set with a recessed front panel preset control.

When Mic 1 and/or Mic 2 are in use, music ducking can also be enabled on a per-zone basis. Additionally, Line 6 input may be set to have priority over any other selected music source in any zone, to facilitate connection of a digital sound store or similar device.

Music level only, or music level and source selection may be controlled remotely in each zone if wished, using standard Cloud RL-1 series or RSL-6 series remote control plates. Each zone section of the Z4MK3 and Z8MK3 is also provided with a multi-purpose facility port. The main purpose of this port is to connect optional remote input plates, which allow mic and/or line level sources located in the zone – such as local mics, DJ consoles, laptops, MP3 player docks, etc. – to be routed to the zone's audio system. Various options are available to configure what priorities sources connected via the facility port have relative to the unit's primary sources. The facility port can also be used as a general purpose, balanced, line level, auxiliary zone input.

- Provides flexible music, paging and announcement facilities in four (Z4MK3) or eight (Z8MK3) zones
- Front panel user controls for music source, music level and Mic 1/Mic 2 level in each zone
- Six (unbalanced) stereo line inputs with individual gain trim controls
- Two general-purpose balanced mic inputs – 15 V phantom power available on either or both
- Separate balanced paging mic input – 15 V phantom power available
- Contact closure access port for paging zone selection
- 100 Hz hi-pass filter on all mic inputs
- Sensitivity and HF/LF EQ adjustment for each mic input (rear panel)
- Four (Z4MK3) or eight (Z8MK3) electronically-balanced mono zone outputs

- HF/LF music EQ adjustment on each zone output
- Configurable music-under-mic ducking, per zone
- Zone 1 has selectable LINE 6 priority with choice of release times
- Music Mute control input (N/O or N/C) for interface to emergency system
- Compatible with standard Cloud remote control panels: RL-1 series (music level) and RSL-6 series (music level and source selection), per-zone
- Configurable, per-zone facility port for optional remote mic/line (LM-2 series) input plates
- Facility port can act as balanced aux input to each zone
- Optional EQ cards for various installation loudspeakers
- 3U 19" rack-mounting units

Rear Panel Illustrations

Z4MK3 Rear

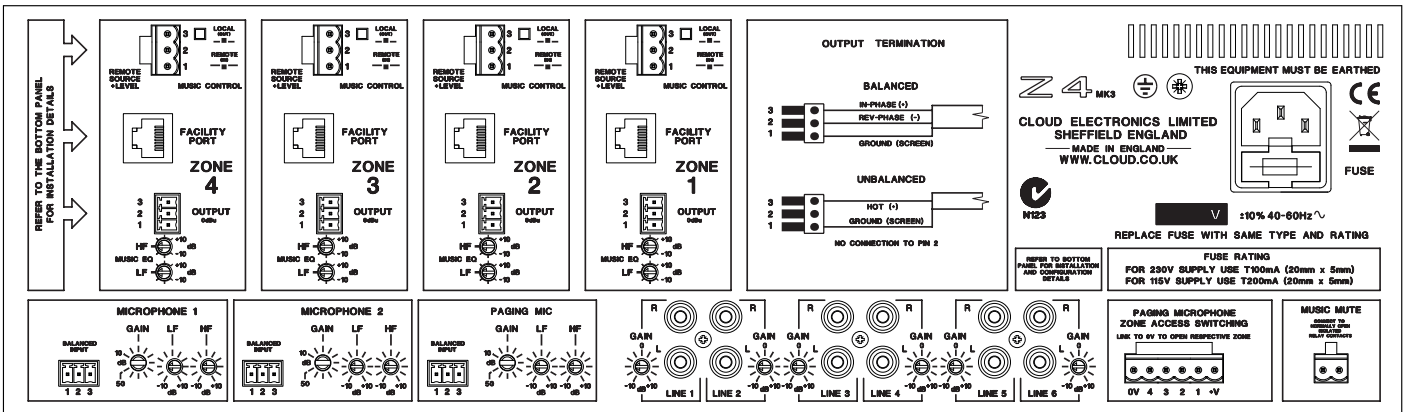

Z8MK3 Rear

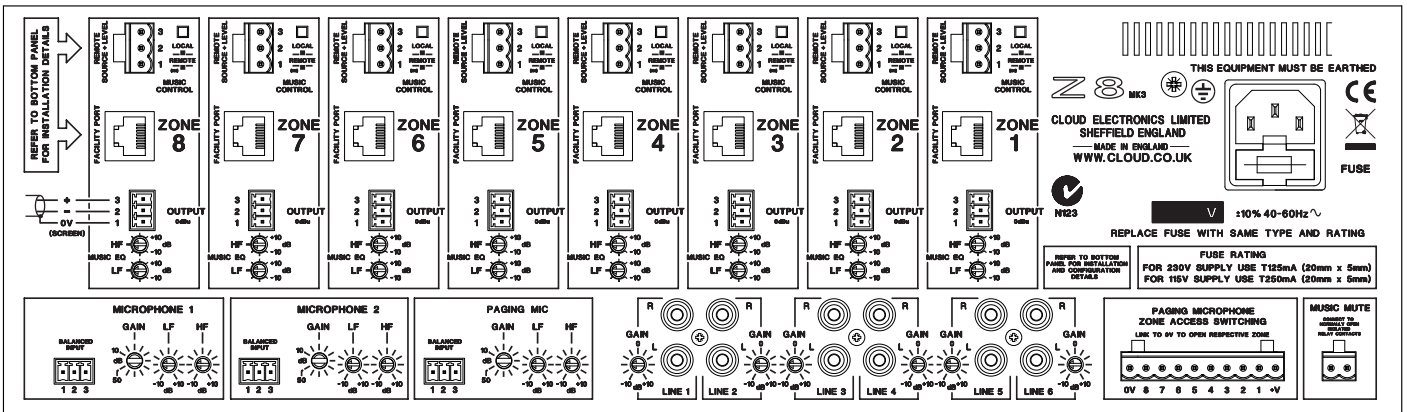

LM-2 remote input/control plate

The usefulness of the Z4MK3 and Z8MK3 can be greatly enhanced with the LM-2 Series of remote input/control plates. An LM-2 provides the following facilities in the remote location where it is installed:

- a microphone to be connected to the audio system
- various types of stereo audio devices (laptops, tablets, MP3 players, DJ consoles, etc.) to be connected to the audio system
- remote control of music source and music level

The LM-2 Series comprises a range of plates in various form factors to suit the standard electrical back boxes in use in the UK, USA and Germany. They are also available in different cosmetic finishes (black and white) to suit room décor.

LM-2 plates are easily wired to the Facility Port (on the Z4/Z8 rear panel) corresponding to the zone in which they are installed, using screened Cat 5 cable and RJ45 connectors. This single connection supplies the necessary DC power as well as all audio connections.

A separate datasheet with full technical details of the LM-2 Series is available.

LM-2W UK



LM-2AW USA

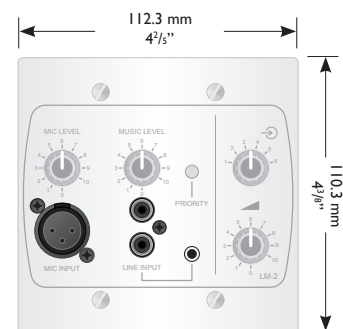

LM-2DW Germany/Austria



Block Diagram - Z8MK3 (8 zones)

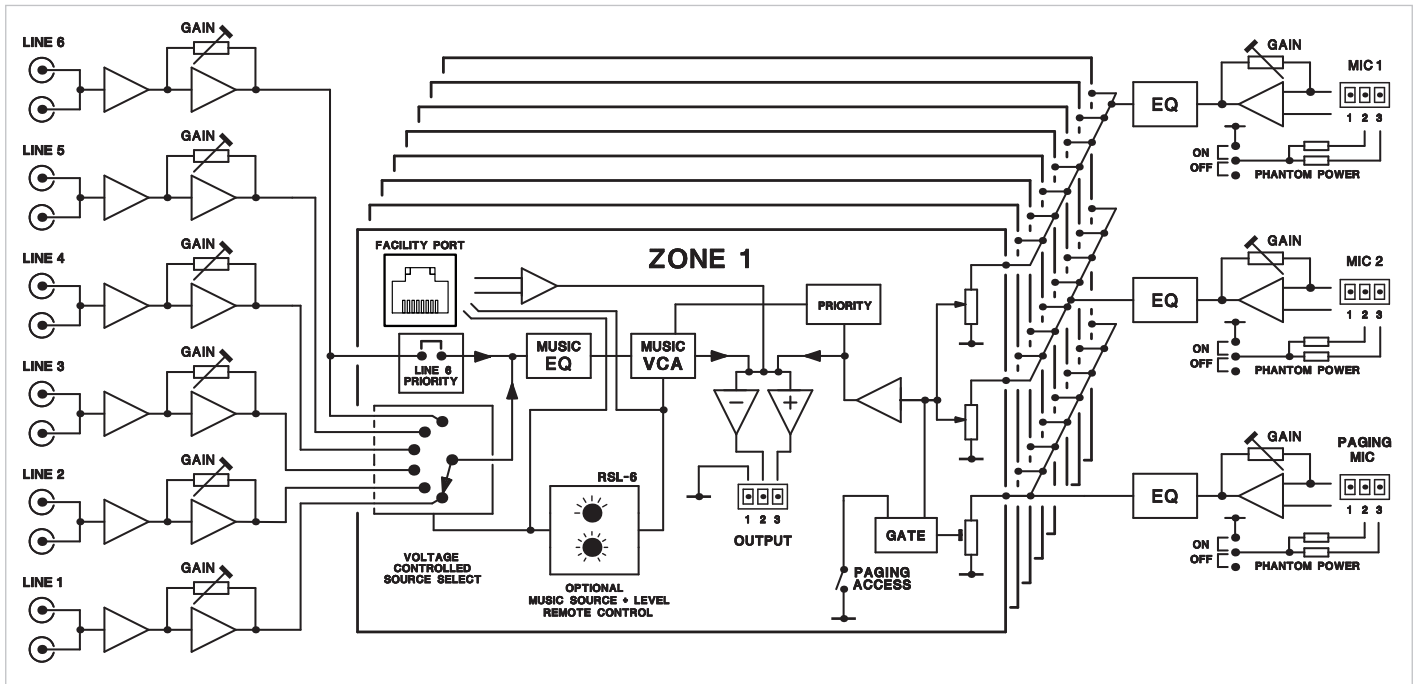

System Example - Installation for 3 Zones

The diagram depicts a system where four possible music (or other audio) sources are made available to three or more zones (areas). Only three are shown for clarity. Points to note:

- Area 1 and Area 3 have remote control plates installed: an RSL-6 (music level and source) in Area 1 and an RL-1 (music level only) in Area 3. These are wired to the Music Control Ports for their respective zone outputs.
- Areas 1 and 2 include LM-2 mic/line input plates, wired to the Facility Ports of Zones 1 and 2 respectively. These would allow both a microphone and a portable stereo music source to be connected in those areas. The LM-2 also provides music source and level control; note that the LM-2 does not require a second connection to the Music Control Port to enable this.
- Area 3 has a Cloud PM series paging microphone, which would be used to originate voice messages to any of the other areas. The paging level to Area 3 (if required) would be adjusted on installation to be at a level that does not cause feedback.

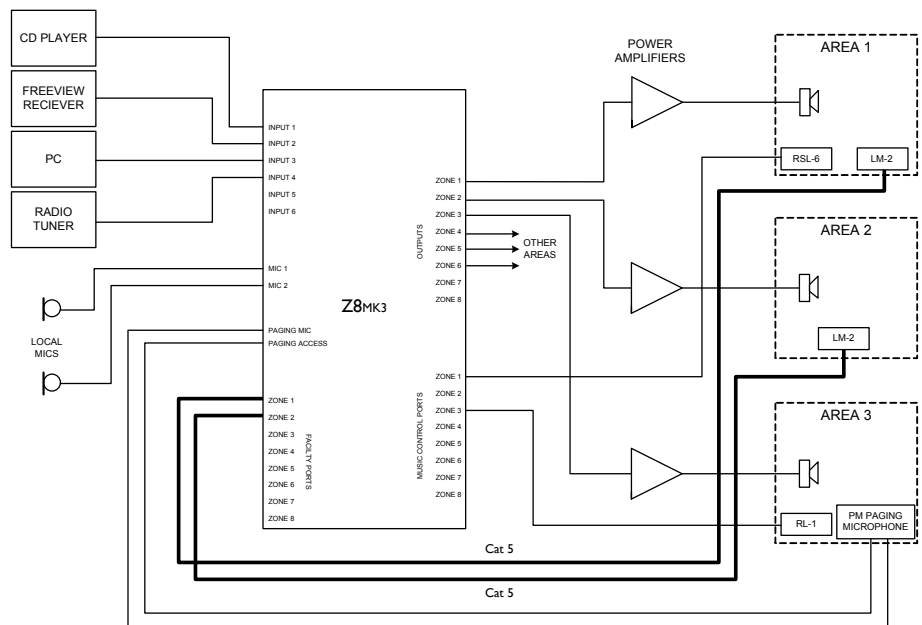

Graphs

Z4MK3/Z8MK3 Music Crosstalk

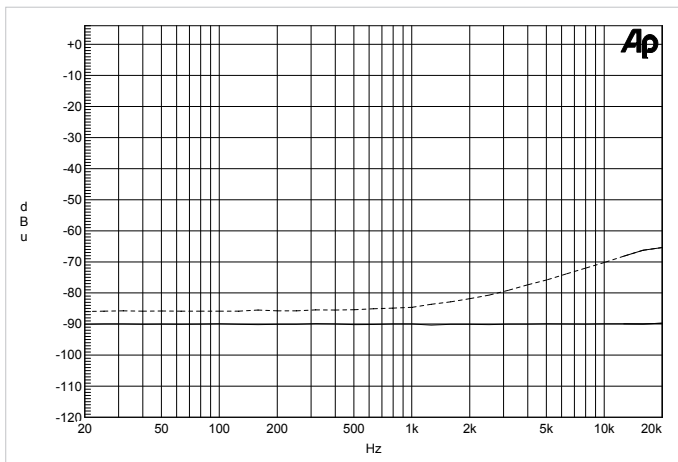

Z4MK3/Z8MK3 Music Output Frequency Response

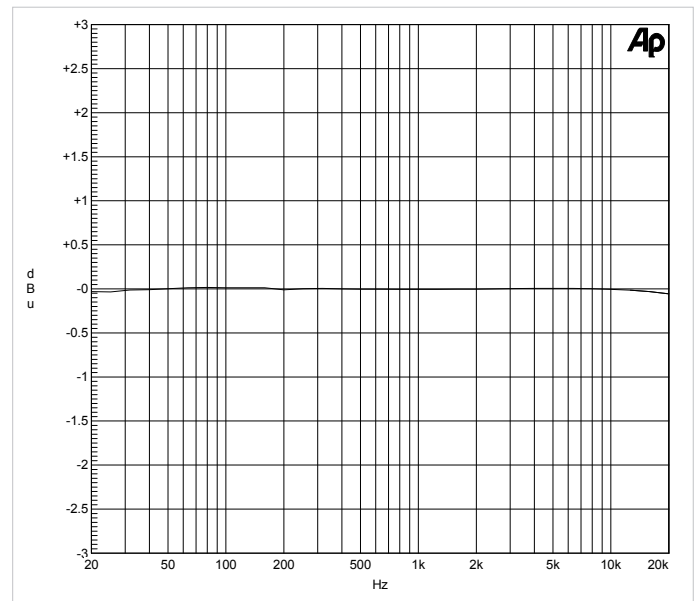

Technical Specifications

Line Inputs

Frequency Response	20 Hz - 20 kHz, ± 0.5 dB
Sensitivity	200 mV (-12.0 dBu) to 2.0V (+8 dBu)
Input Gain Control	20 dB range
Input Impedance	47 k Ω
Headroom	>20 dB
Noise	<-90 dBu rms typical @ 0 dB gain, 22 Hz - 22 kHz
Equalisation	LF: ± 10 dB @ 50 Hz HF: ± 10 dB @ 10kHz

Microphone Input

Frequency Response	100 Hz -3 dB (filter) to 20 kHz, ± 0.5 dB
Gain Range	10 dB to 50 dB
Input Impedance	>2 k Ω (balanced)
Common Mode Rejection	>70 dB @ 1 kHz
Headroom	>20 dB
Noise	-120 dB EIN, 22 Hz -22 kHz ($Z_s = 150\Omega$)
Equalisation	LF: ± 10 dB @ 100 Hz, HF: ± 10 dB @ 5 kHz

Outputs

Output	0 dBu (775 mV) balanced
Minimum load impedance	600 Ω
Maximum output level	+20 dBu (7.75 V)

General

Power Input	230V/115V $\pm 10\%$, 40 – 60 Hz
Power consumption	Z8MK3: 28 VA Z4MK3: 20 VA
Fuse Rating	Z8MK3: T125 mA 230V, T250 mA 115V Z4MK3: T100 mA 230V, T200 mA 115V
Fuse Type	20 mm x 5 mm class 3T 250V
Dimensions (w x h x d)	482.6 mm x 132.5 mm (3U) x 160 mm 19" x 5 1/8" x 6 1/8"
Weight	Z8MK3: 4.40 kg / 9.7lbs Z4MK3: 3.83 kg / 8.4lbs

Architect's and Engineer's Specification

The mixer shall be available in two versions, with four or eight electronically balanced mono outputs (zones) on rear panel multipin connectors respectively. Unless otherwise stated, all specifications which follow shall apply to both versions, with the two versions differing only in those facilities specific to the outputs.

The mixers shall be equipped with six unbalanced stereo music inputs on rear panel phono sockets (RCA jacks) and three electronically balanced microphone inputs (plug-in screw terminal connectors). One of the microphone inputs shall be configured specifically to operate with paging microphones.

The music input to each zone and the music level in the zone shall be adjustable by front panel controls. Each zone shall also have its own front panel microphone level controls, one per microphone input. The level control for the paging microphone input shall be of the preset type and recessed behind the panel. It shall be possible to control the level of the music source independently of the microphone levels in each channel.

Each music input shall have a rear panel input gain trim control with a range of 20 dB. Two-band equalisation adjustment shall be provided on the rear panel for the music signal in each zone. Two-band equalisation adjustment shall also be available for each microphone input; phantom power shall be available at any or all microphone inputs when selected by internal jumpers.

A control input shall be provided to activate the paging microphone input by external contact closure, and route its signal to any or all zones, replacing the music signal while the contacts are closed. It shall also be possible to configure the mixer to perform the following functions: i) detection of a signal on either non-paging microphone input will automatically reduce the music level by 30 dB, ii) detection of a signal on the paging microphone input will automatically route the signal to all zones, iii) one line input will automatically override all others in all zones, even if unselected.

Optional remote control panels shall be available to permit control of i) music level in any zone; ii) music source selection and music level in any mixer channel; it shall be possible to retrofit these to the mixer at any time. The remote control panels shall connect via a rear panel multipin connector. It shall be possible to

disable either the front panel music level or the music level and music source selection controls by moving internal jumpers. An external control input shall be provided to allow muting of the music source by a fire alarm or other external emergency system via isolated, 'voltage-free' contacts, and this input shall be configurable to respond to either a short or open external circuit. Front panel LED indication of the muting action shall be provided.

Each zone output shall be provided with an additional balanced input on a multipin connector; this input shall feed only its own zone. An optional input plate shall be available to allow the connection of external microphone and line level audio sources at a remote location, and this plate shall connect to the mixer via the multipin connector, which also shall supply DC power and all necessary control interface connections. The remote input plate shall allow the connection of one microphone and one stereo line level input, with individual level controls for each input, and sum the inputs. Controls shall also be provided for music source selection and music level in the zone to which it is connected. It shall be possible to enable the mixer's music ducking facility from the plate.

The mixer shall accept internal plug-in equaliser cards to permit use with compatible loudspeakers. It shall be possible to fit these in any or all of the zone outputs.

The mixer shall be built in a 3U steel chassis for mounting in a standard 19" rack. The mixer will be fitted with a front-panel power switch with LED indication. Two mains supply variants shall be available: 230V or 115V. Mains supply shall be connected via a detachable IEC cable.

The mixers shall be the Cloud Z4MK3 (four output zones) and the Cloud Z8MK3 (eight output zones); the optional remote control panels shall be the Cloud RL-1 series (music level only) and the Cloud RSL-6 series (music level and source selection). The optional remote input plate shall be the Cloud LM-2.

Cloud Electronics Limited

140 Staniforth Road, Sheffield, S9 3HF, England.
Telephone: +44 (0)114 244 7051 Fax: +44 (0)114 242 5462
Web: www.cloud.co.uk E-mail: info@cloud.co.uk

Cloud Electronics USA

2065 Sidewinder Drive, Suite 200, Park City,
Utah 84060, United States of America.
Toll Free: 0855 810 0161
Web: www.cloudusa.pro E-mail: sales@cloudusa.pro